

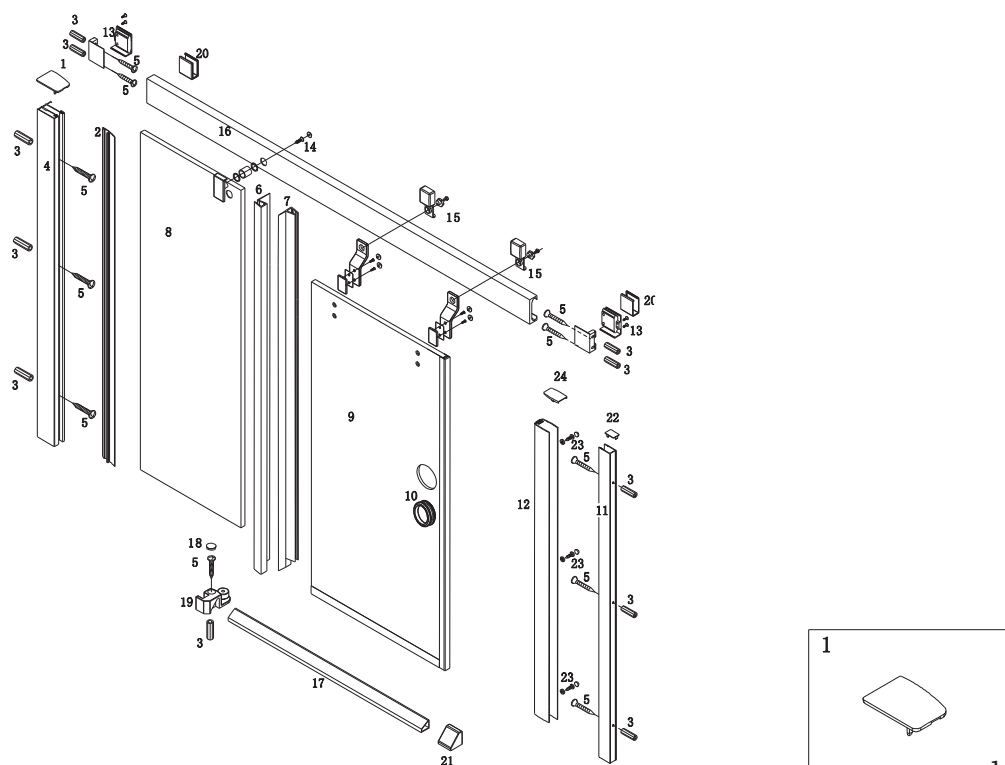















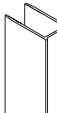
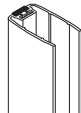
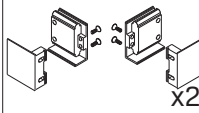
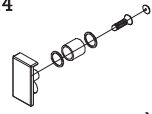
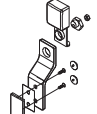
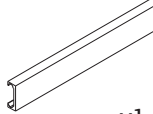

INSTRUKCJA MONTAŻU DRZWI PRYSZNICOWYCH PORTA

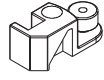
Przed przystąpieniem do montażu przeczytaj uważnie instrukcję oraz sprawdź zestaw pod kątem kompletności i ewentualnych uszkodzeń. W razie problemów prosimy skontaktować się ze sprzedawcą.

LISTA CZĘŚCI

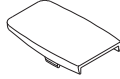

2		x1	3		x11	4		x1	5	ST4X30 	x11	6		x1	7		x1
8		x1	9		x1	10		x1	11		x1	12		x1	13	P L 	x2
14		x1	15		x2	16		x1	17		x1	18		x1	19		x1
		x2	21		x1	22		x1	23		x3	24		x1	25		x1

